

# Caddy

SERIES



**CADDY 10 UL**

**CADDY 5 UL**



OPERATOR'S MANUAL

## 1 TECHNICAL CHARACTERISTICS

		10/1	10/2	5/2	5/3	5/4
Transparent removable bowls	n	1	2	2	3	4
Capacity of each bowl,	l	10	10	5	5	5
approx.						
Dimensions:						
width	cm	23	47	23	35	47
depth	cm	34	34	34	34	34
height	cm	58	58	58	58	58
Net weight, approx.	kg	16	26	17	21	26
Gross weight, approx.	kg	17	29	19	24	29
Adjustable thermostats	n	1	2	1	1	2
Hermetic compressor						
Air-cooled condenser						
Overload protector						
Noise level lower than 70 dB (A)						



IMPORTANT

Read electrical ratings written on the data plate under the individual units. The serial number of the unit is preceded by the symbol #. Data plate specifications will always supersede the information in this manual.

Specifications are subject to change without notice.

## 2 INTRODUCTION

Please read all sections of this manual thoroughly to familiarize yourself with all aspects of the unit.

Like all mechanical products, this machine will require cleaning and maintenance. Besides, dispenser working can be compromised by operator's mistakes during disassembly and cleaning. It is strongly recommended that personnel responsible for the equipment's daily operations, disassembly, cleaning, sanitizing and assembly, go through these procedures in order to be properly trained and to make sure that no misunderstandings exist.

## 3 INSTALLATION

- 1 - Remove the corrugate container and packing materials and keep them for possible future use.
- 2 - Inspect the uncrated unit for any possible damage. If damage is found, call the delivering carrier immediately to file a claim.
- 3 - Install the unit on a counter top that will support the combined weight of dispenser and product.

- 4 - A minimum of 15 cm (6") of free air space all around the unit should be allowed to guarantee adequate ventilation.
- 5 - Ensure that the legs are screwed tightly into the base of the machine.
- 6 - In case of units with gravity faucet, install it according to this handbook instructions (chapter 5.3.4 ASSEMBLY).
- 7 - Before plugging the unit in, check if the voltage is the same as that indicated on the data plate. Plug the unit into a grounded, protected single phase electrical supply according to the applicable electrical codes and the specifications of your machine. When the unit has no plug, install a proper grounded plug, in compliance with electrical codes in force in your area, suitable to at least 10 Amp 250 Volt (220-230 Volts 50-60 Hz areas) and 20 Amp 250 Volt (100-115 Volts 50-60 Hz areas) applications. Should you prefer to connect the unit directly to the mains, connect the supply cord to a 2-pole wall breaker, whose contact opening is at least 3 mm. Do not use extension cords.



ATTENTION

Failure to provide proper electrical ground according to applicable electrical codes could result in serious shock hazard.

- 8 - The unit doesn't come presanitized from the factory. Before serving products, the dispenser must be disassembled, cleaned and sanitized according to this handbook instructions (chapter 5.3 CLEANING AND SANITAZING PROCEDURES).

## 4 TO OPERATE SAFELY

- 1 - **Do not** operate the dispenser without reading this operator's manual.
- 2 - **Do not** operate the dispenser unless it is properly grounded.
- 3 - **Do not** use extension cords to connect the dispenser.
- 4 - **Do not** operate the dispenser unless all panels are restrained with screws.
- 5 - **Do not** obstruct air intake and discharge openings: 15 cm (6") minimum air space all around the dispenser.
- 6 - **Do not** put objects or fingers in panels louvers and faucet outlet.
- 7 - **Do not** remove bowls, augers and mixers for cleaning or routine maintenance unless the dispenser is disconnected from its power source.

## 5 OPERATING PROCEDURES

- 1 - Clean and sanitize the unit according to the instructions in this manual. See chapter 5.3 CLEANING AND SANITIZING PROCEDURES.
- 2 - Fill the bowls with product to the maximum level mark. Do not overfill.  
The exact quantity of product (expressed as liters and gallons) is shown by marks on the bowl.
- 3 - In case of products to be diluted with water, pour water into bowl first, then add correct quantity of product. In case of natural squashes, it is advisable to strain them, in order to prevent pulps from obstructing the faucet outlet.
- 4 - Install the covers and check that they are correctly placed over the bowls.
- 5 - Set the control switches as shown in chapter 5.1 DESCRIPTION OF CONTROLS.
- 6 - The dispenser must always run with the covers installed to prevent a possible contamination of the product.
- 7 - Always leave the dispenser on, as the refrigeration stops automatically when the beverage reaches the dispensing temperature. The mixing devices will continue to turn.
- 8 - To maintain a high standard of flavour, keep refrigeration and mixing devices on during the night when beverage is in the bowl.

### 5.1 DESCRIPTION OF CONTROLS

The dispenser is equipped with the power switch only. When it is set to position I, the power is turned on both to mixing devices and to refrigeration.

	<h2>IMPORTANT</h2>
<p>Should dispenser be operated without using all the bowls (<u>left bowl, facing the unit from dispensing side, must be always used</u>) it is advisable to remove (see 5.3.1 DISASSEMBLY paragraph) the pump impeller from the empty bowls. If operated without liquid, the impeller would be seriously damaged.</p>	

**Beverage temperature adjustment (model 10/1 only):** turn the knob, located on the right of the faucet side of the dispenser, toward right to decrease temperature or viceversa.

### 5.2 HELPFUL HINTS

- 1 - The length of time for cooling down the product is governed by many variables, such as ambient temperature and beverage initial temperature.
- 2 - To shorten product cooling down time and

increase productivity, it is advisable to pre-chill the product to be used in the dispenser.

- 3 - To shorten product cooling down time and increase productivity, the bowl should be refilled after the product level drops lower than half and at the start of each day.
- 4 - The dispenser must be able to emit heat. In case it seems excessive, check that no heating source is close to the unit and air flow through the slotted panels is not obstructed by wall or boxes. Allow at least 15 cm (6") of free clearance all around the dispenser.  
In any case if the product in the bowls is cold the unit is running properly.

### 5.3 CLEANING AND SANITIZING PROCEDURES

Cleaning and sanitizing of the dispenser are recommended to guarantee the conservation of the best product taste and the highest unit efficiency. This section is a procedural guideline only and is subject to the requirements of the local Health Authorities.

Prior to the disassembly and cleaning, the machine must be emptied of product.

#### 5.3.1 DISASSEMBLY

	<h2>ATTENTION</h2>
<p>Before any disassembly and/or cleaning procedure make sure that the dispenser is disconnected from its power source by unplugging it or switching off the 2-pole wall breaker.</p>	

- 1 - Remove cover from the bowl.
- 2 - Uncouple (1) the pump cover retainer and lift it up and out (2) (see figure 1).

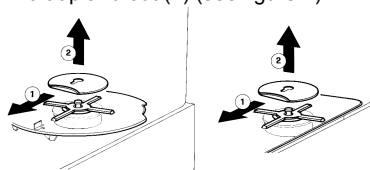

figure 1

- 3 - Remove the pump cover.
- 4 - Remove the empty bowl by lifting first its rear side (opposite to faucet side) up

and off bowl gasket (see figure 2).

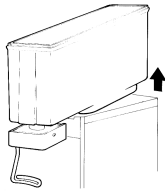

figure 2

- 5 - Remove the bowl gasket.
- 6 - Remove the pump impeller from its location.
- 7 - **Pinch tube faucet:** push the dispensing handle (1) and take the pinch tube off from its seat (2) (see figure 3).

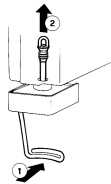

figure 3

- 8 - **Gravity faucet:** extract the piston (1) and then remove the dispensing handle (2-3) (see figure 4).

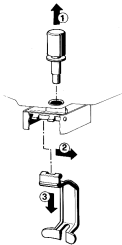



figure 4

- 9 - Slide drip tray out and empty it.

### 5. 3. 2 CLEANING

 <b>ATTENTION</b>
<p>Before any disassembly and/or cleaning procedure make sure that the dispenser is disconnected from its power source by unplugging it or switching off the 2-pole wall breaker.</p>

 <b>IMPORTANT</b>
<p>Do not attempt to wash any machine components in a dishwasher.</p>

- 1 - Prepare at least two gallons of a mild cleaning solution of warm (45-60 °C 120-140 °F) potable water and dishwashing detergent. Do not use abrasive detergent. Important: if present, follow label directions, as too strong a solution can cause parts damage, while too mild a solution will not provide adequate cleaning.

 <b>IMPORTANT</b>
<p>In order to prevent any damages to the dispenser use only a detergent suitable with plastics parts.</p>

- 2 - Using a brush, suitable for the purpose, thoroughly clean all disassembled parts in the cleaning solution.

 <b>ATTENTION</b>
<p>When cleaning the machine, do not allow excessive amounts of water around the electrically operated components of the unit. Electrical shock or damage to the machine may result.</p>

- 3 - Rinse all cleaned parts with cool clean water.

### 5. 3. 3 SANITIZING

Sanitizing should be performed immediately prior to starting the machine. Do not allow the unit to sit for extended periods of time after sanitization.

- 1 - Wash hands with a suitable antibacterial soap.
- 2 - Prepare at least two gallons of a warm (45-60 °C 120-140 °F) sanitizing solution (100 PPM available chlorine concentration or 1 spoon of sodium hypochlorite diluted with half a gallon of water) according to your local Health Codes and manufacturer's specifications.
- 3 - Place the parts in the sanitizing solution following manufacture 's specifications (about five minutes).
- 4 - Place the sanitized parts on a clean dry surface to air dry.
- 5 - Wipe clean all exterior surfaces of the unit. Do not use abrasive cleaner.

### 5. 3. 4 ASSEMBLY

- 1 - Slide the drip tray into place.
- 2 - **Pinch tube faucet:** push the dispensing handle (1) and insert the pinch tube into its vertical seat in the bowl bottom(2). Lightly pull the pinch tube end downwards til it is

well arranged (3) (see figure 5).

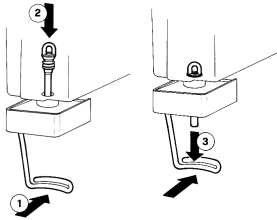

figure 5

- 3 - Gravity faucet: install the faucet handle (1-2) and the piston with its gasket (3) (see figure 6).

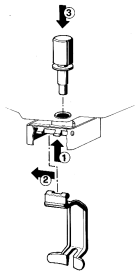

figure 6

- 4 - Fit the bowl gasket to the evaporator. Note: the largest brim of the gasket must face against the drip plate (see figure 8).

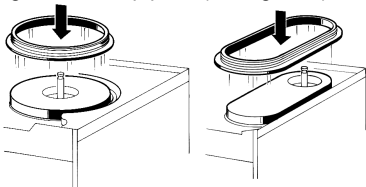

figure 7

- 5 - Place bowl on the unit. Wet the gasket for ease of insertion.  
**CADDY 5** : be sure first that the faucet top (1) is under the tooth jutting (2) out of the drip plate (see figure 8).

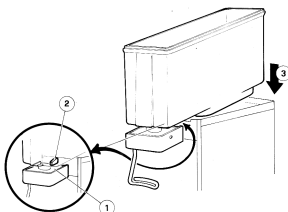

figure 8

- 6 - Replace the pump impeller and its cover and hook the retainer.
- 7 - Use fresh product to chase any remaining

sanitizer from the bowl(s). Drain this solution. Do not rinse out the machine.

## 5. 4 IN-PLACE SANITIZATION

The In-Place Sanitization prior to starting the machine may be performed, if needed, only as further precaution, in addition to the Disassembled Parts Sanitization described before, but never in lieu of it.

- 1 - Prepare two gallons of a warm (45-60°C, 120-140 °F) sanitizing solution (100 PPM available chlorine concentration or 1 spoon of sodium hypochlorite diluted with half a gallon of water) according to your local Health Codes and manufacturer's specifications.
- 2 - Pour the solution into the bowl(s).
- 3 - Using a brush suitable for the purpose, wipe the solution on all surfaces protruding above the solution-level and on the underside of the top cover(s).
- 4 - Install the top cover(s) and operate the unit. Allow the solution to agitate for about two minutes. Drain the solution out of the bowl(s).
- 5 - Use fresh product to chase any remaining sanitizer from the bowl(s). Drain this solution. Do not rinse out the machine.

## 6 ROUTINE MAINTENANCE

**Daily:** inspect the machine for signs of product leaks past seals and gaskets. If proper assembly does not stop leaks around seals or gaskets, check for improper lubrication, worn or damaged parts. Replace parts as needed with original spare parts from the supplier.

### 6. 1 MAINTENANCE (TO BE CARRIED OUT BY QUALIFIED SERVICE PERSONNEL ONLY)

**Montly:** clean all internal components, primarily the condenser, using compressed air. To clean these internal parts, unplug the unit or switch off the 2-pole wall breaker, then remove front panel (dispensing side).

Condenser fins are very sharp. Use extreme caution when cleaning.

# CADDY 10 U/UL

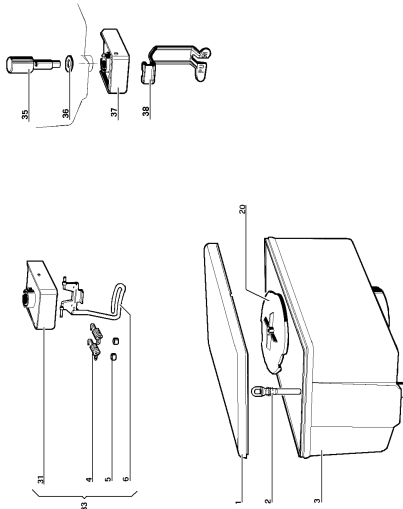

- 1 21980-00000 Cover
- 2 21703-00000 Pinch tube
- 3 22800-18730 10 lt bowl
- 4 21705-00000 Faucet spring
- 5 21704-00000 Rubber spring retainer
- 6 21701-00001 Push handle
- 7 21983-00000 Pump cover fixing clip
- 8 33800-05700 Evaporator assembly
- 9 21125-00000 Switch
- 10 22800-05100 Switch cap
- 11 22800-19300 Thermostat knob
- 12 33800-00803 Magnet
- 13 22800-04800 Motor bracket
- 14 22800-18901 Fan/pump motor
- 15 \*\*\*
- 16 \*\*\*
- 17 22800-18400 Caddy 7/1-10/1 dispensing side panel
- 17 22800-18420 Caddy 10/2 dispensing side panel
- 18 22800-00500 Drip tray cover
- 19 22800-00600 Drip tray (grey)
- 20 22800-18800 Pump cover

- 21 22081-00001 Bowl gasket
- 22 33800-05401 Impeller for 7 lt bowl
- 23 22800-19900 Central pivot
- 24 22040-00000 Central pivot OR
- 25 10554-45000 Clip
- 26 21087-00001 Thermostat
- 27 22800-18301 Cabinet for Caddy 7/1 - 10/1
- 27 22800-18321 Cabinet for Caddy 10/2
- 28 22800-10000 Leg
- 29 22800-05500 Terminal block with cable clamp
- 30 22800-20700 Fan
- 31 01702-00000 Faucet cover for pinch tube faucet
- 31 22800-04410 Faucet cover for gravity faucet
- 33 33800-08900 Faucet assembly
- 34 33800-05402 Impeller for 10 lt bowl
- 35 22800-21900 Faucet piston
- 36 10028-02500 Faucet gasket
- 37 22800-04410 Faucet cover
- 38 22800-02303 Push handle

\*\*\*: Please order what printed on piece

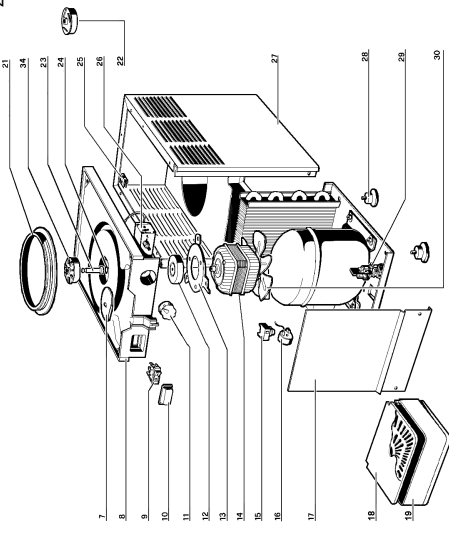

## WIRING DIAGRAM

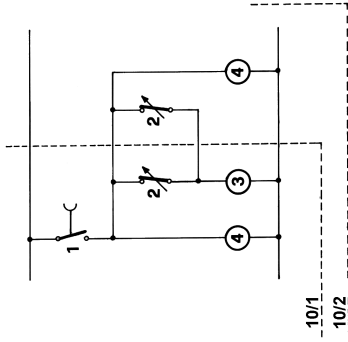

- 1 Switch
- 2 Thermostat
- 3 Compressor
- 4 Fan/Pump motor

# CADDY 5 U/UL

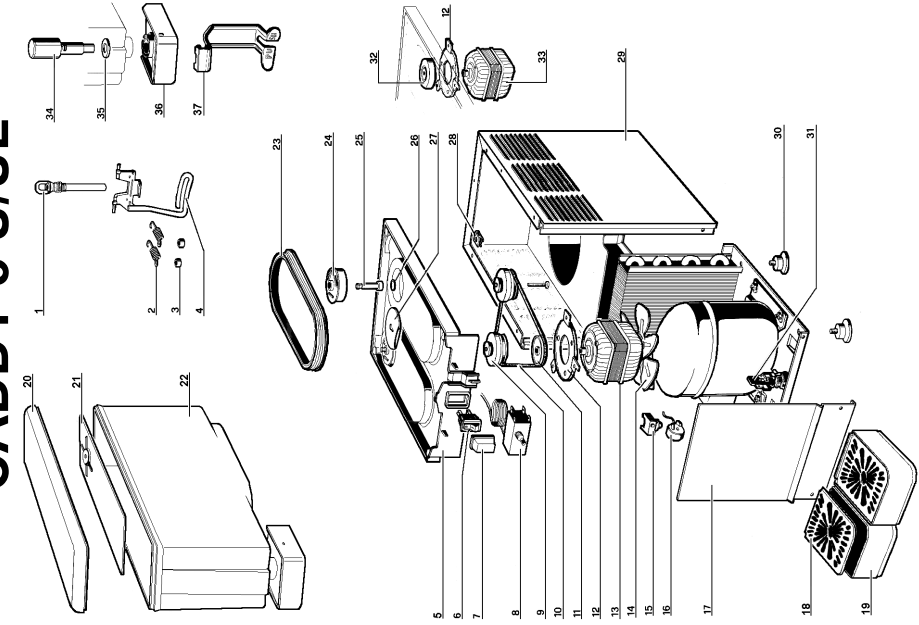

- 1 21703-00000 Pinch tube
- 2 21705-00000 Faucet spring
- 3 21704-00000 Spring holder
- 4 01701-00001 Push handle
- 5 33800-05710 Evaporator assembly
- (5) 33800-05762 Evaporator assembly Caddy 5/3
- 6 21125-00000 Switch
- 7 22800-05100 Switch cap
- 8 21087-00000 Thermostat
- 9 33800-00811 Pulley, magnet and spacer assembly
- 10 22800-01800 Belt
- 11 22800-02201 Driving pulley
- 12 22800-04800 Motor bracket
- 13 22800-18911 Fan/pump motor
- 14 22800-20700 Fan
- 15 \*\*\*: Relay
- 16 \*\*\*: Overload protector
- 17 22800-18400 Caddy 5/2 dispensing side panel
- 17 22800-18410 Caddy 5/3 dispensing side panel
- 17 22800-18420 Caddy 5/4 dispensing side panel
- 18 22800-00500 Caddy 5/2, 5/4 drip tray cover
- 18 22800-00510 Caddy 5/3 drip tray cover
- 19 22800-00600 Caddy 5/2, 5/4 drip tray
- 19 22800-00610 Caddy 5/3 drip tray
- 20 22800-09110 Bowl cover

- 21 22800-18810 Pump cover
- 22 33800-05615 Bowl and faucet asbly for pinch tube faucet
- 22 33800-05617 Bowl and faucet asbly for gravity faucet
- 23 22800-17200 Bowl gasket
- 24 33800-05401 Pump Impeller
- 25 22800-19900 Central pivot
- 26 22040-00000 Central pivot OR
- 27 21983-00000 Pump cover retainer
- 28 10554-45000 Clip
- 29 22800-18301 Cabinet for Caddy 5/2
- 29 22800-18311 Cabinet for Caddy 5/3
- 29 22800-18321 Cabinet for Caddy 5/4
- 30 22800-10000 Rubber leg
- 31 22800-06500 Terminal block with cable clamp
- (32) 33800-08003 Motor magnet for Caddy 5/3
- (33) 22800-04706 Pump motor for Caddy 5/3
- 34 22800-21900 Faucet piston
- 35 10028-02500 Faucet gasket
- 36 22800-04410 Faucet cover
- 37 22800-02303 Push handle

For Caddy 5/3 only  
 ( )  
 \*\*\*: Please order what printed on piece

## WIRING DIAGRAM

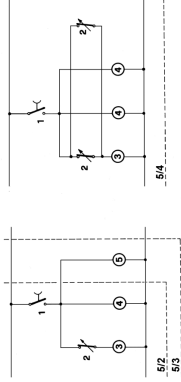

- 1 Switch
- 2 Thermostat
- 3 Compressor
- 4 Fan/Pump motor
- 5 Pump



## **Ugolini S.p.A.**

via dei Pioppi, 33  
20090 Opera MILANO ITALY  
[www.ugolinispa.com](http://www.ugolinispa.com)  
tel ++39 2 5300591  
fax ++39 2 530059260  
E-mail: [sales@ugolinispa.com](mailto:sales@ugolinispa.com)